



#MoodNyssaPattern

“The Nyssa Dress”

Sizes 0/2 to 20/22

Stop!

Print just this page first to check accuracy.
The Mood square to the left should measure
2 inches. Print “actual size” (no scaling).

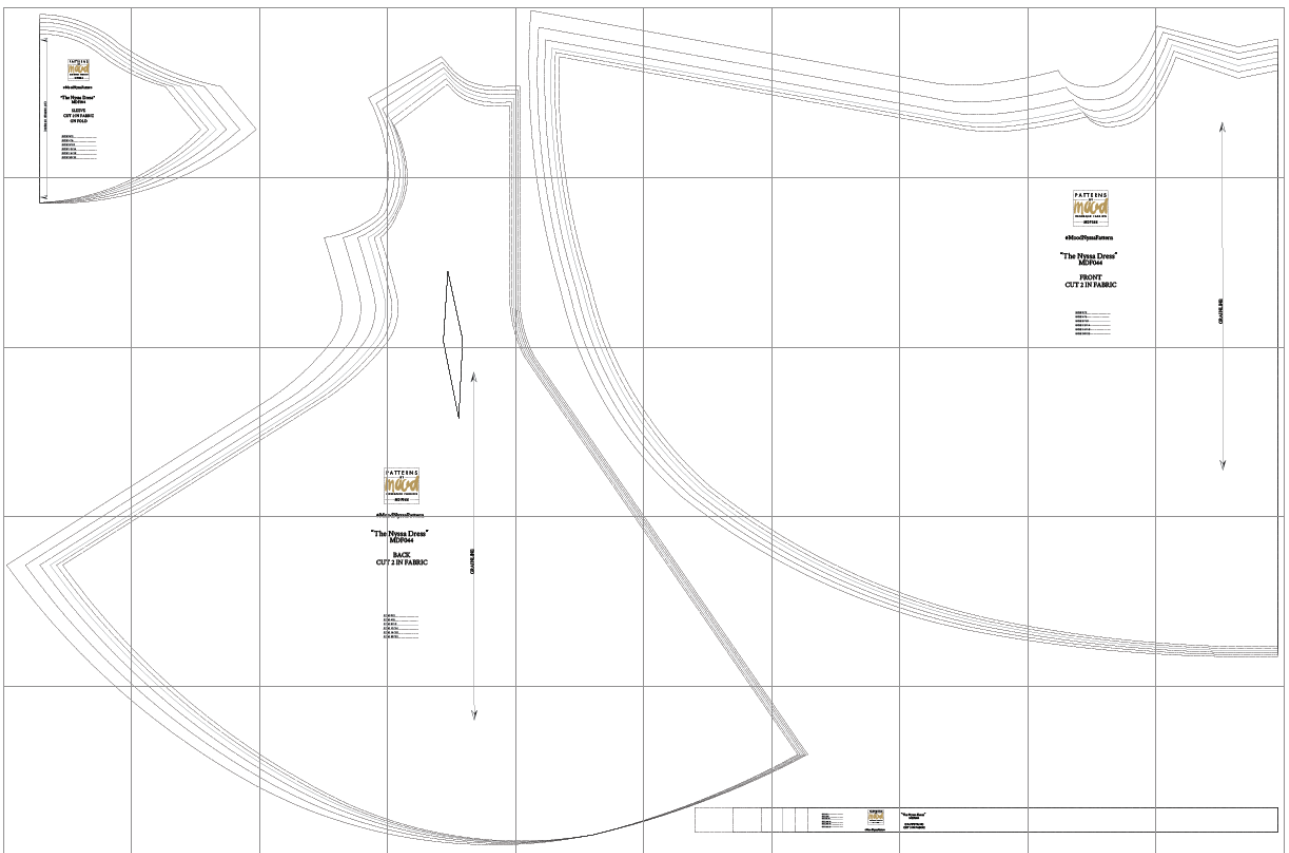

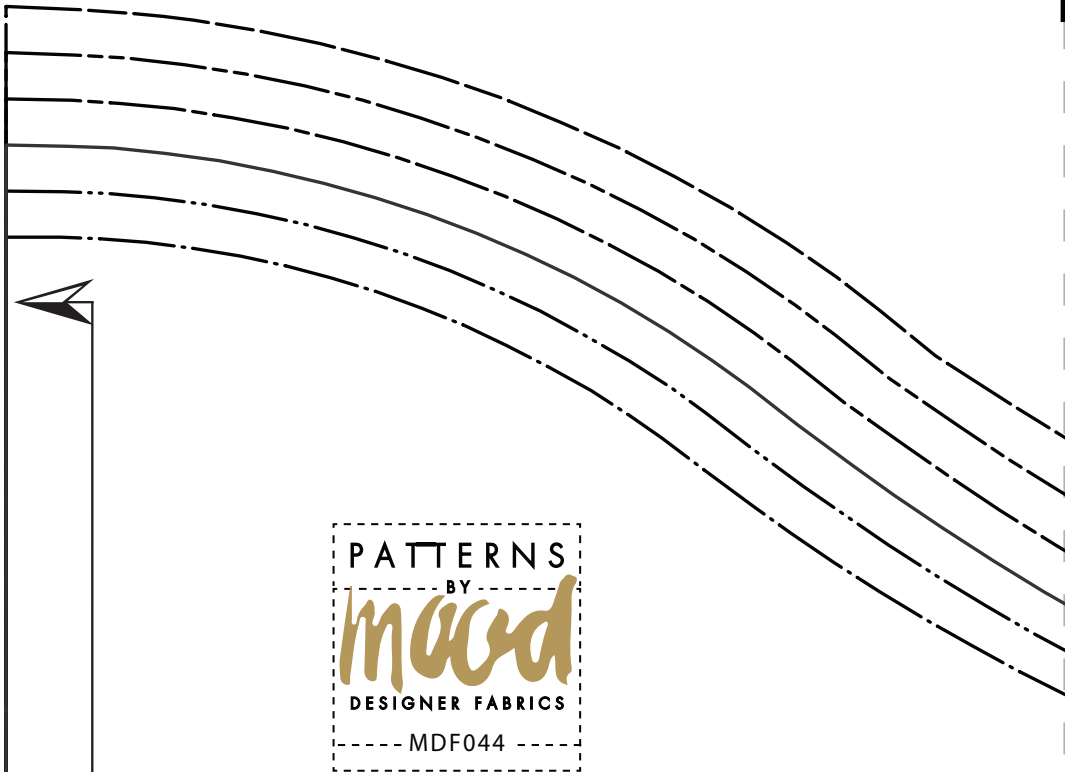

#MoodNyssaPattern

“The Nyssa Dress”
MDF044

SLEEVE
CUT 2 IN FABRIC
ON FOLD

CUT ON FOLD OF FABRIC

SIZE 0/2

SIZE 4/6

SIZE 8/10

SIZE 12/14

SIZE 16/18

SIZE 20/22

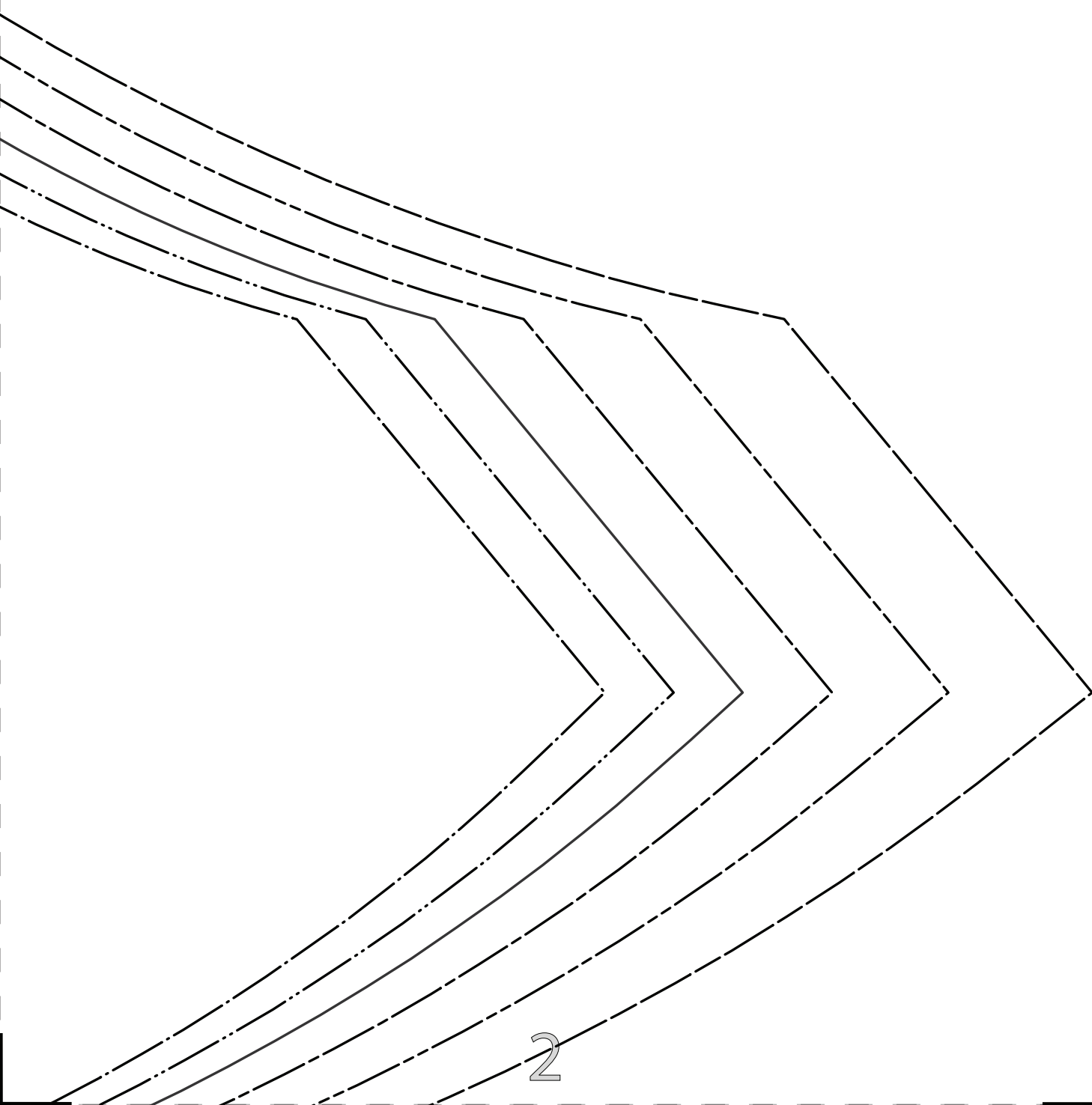

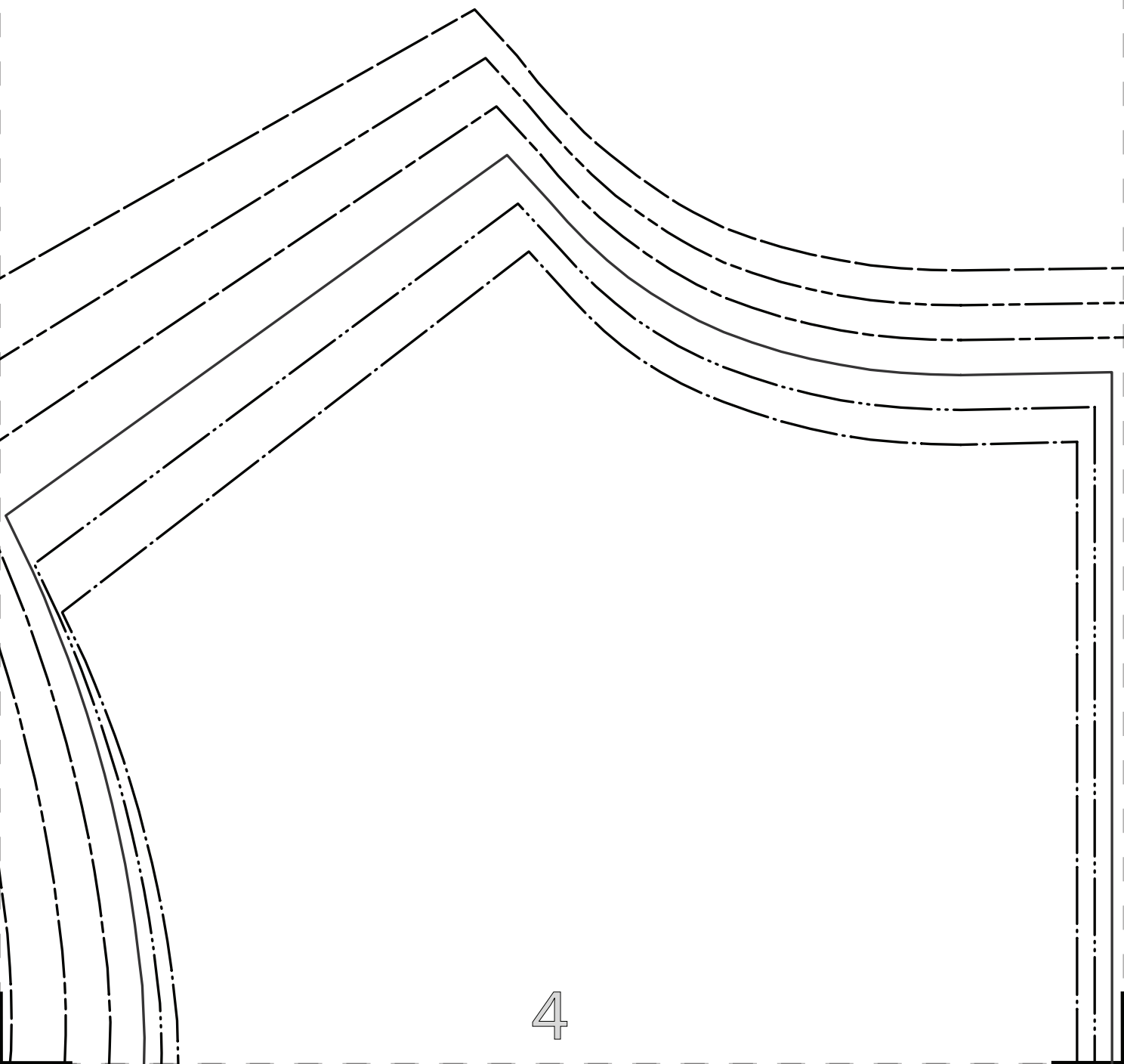

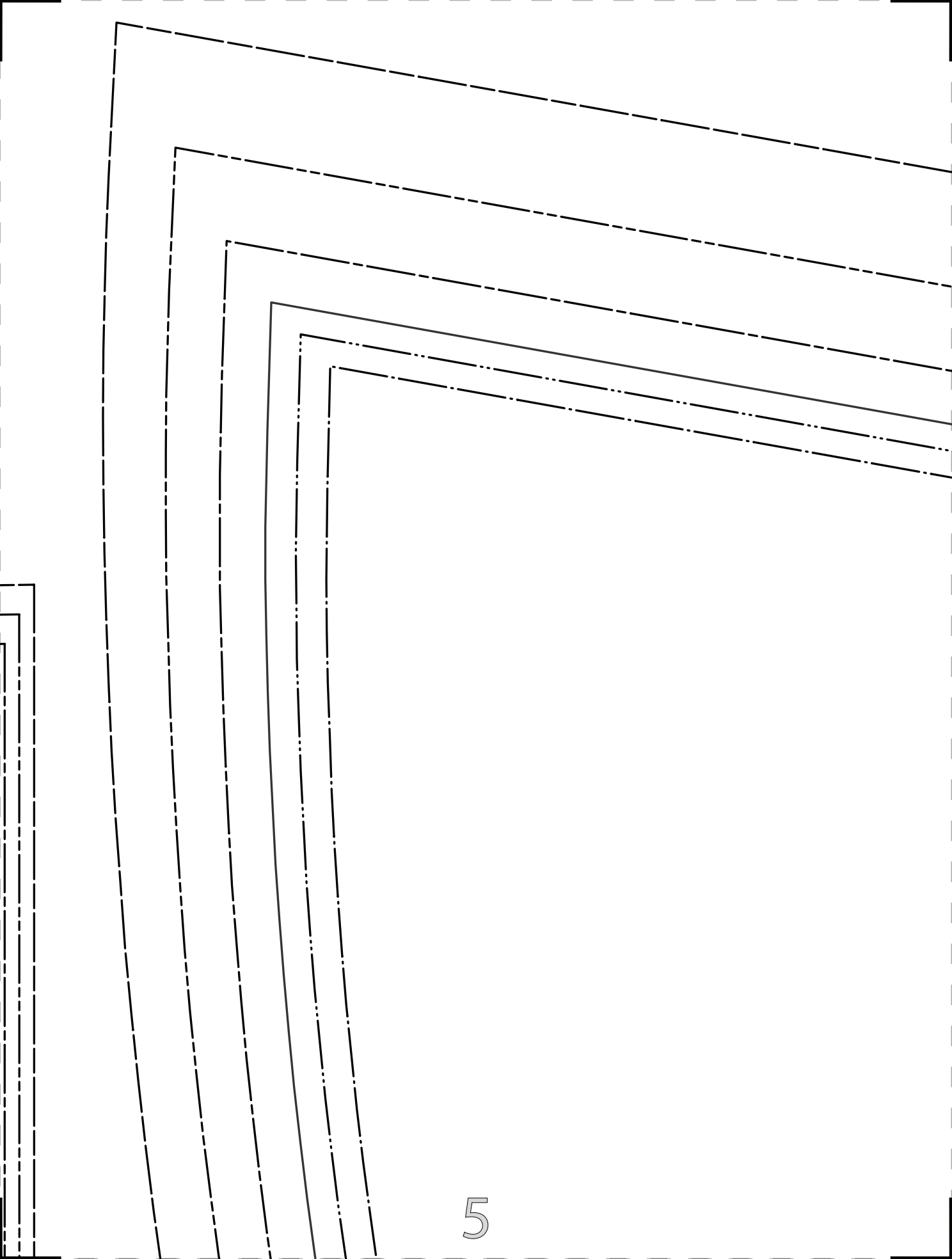

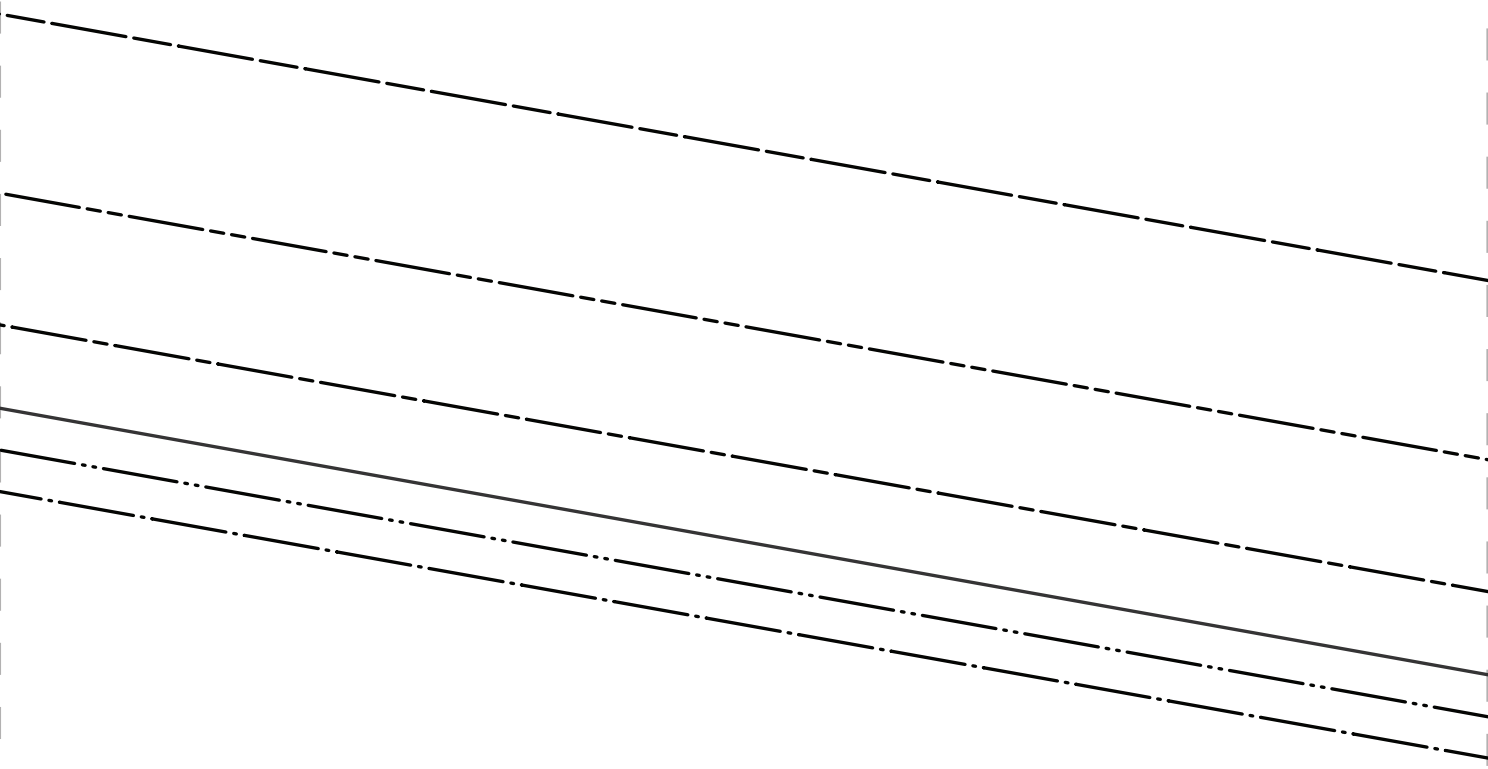

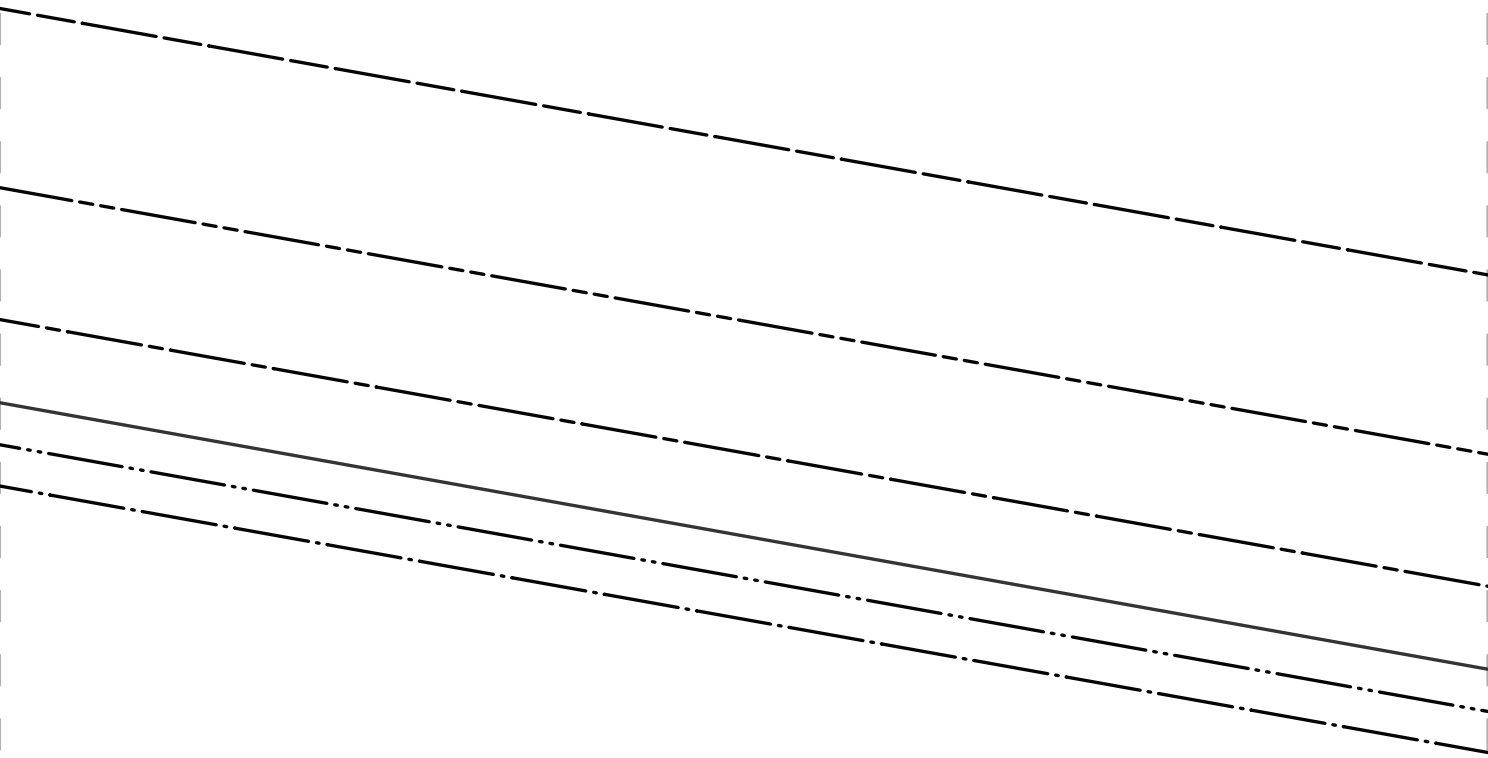

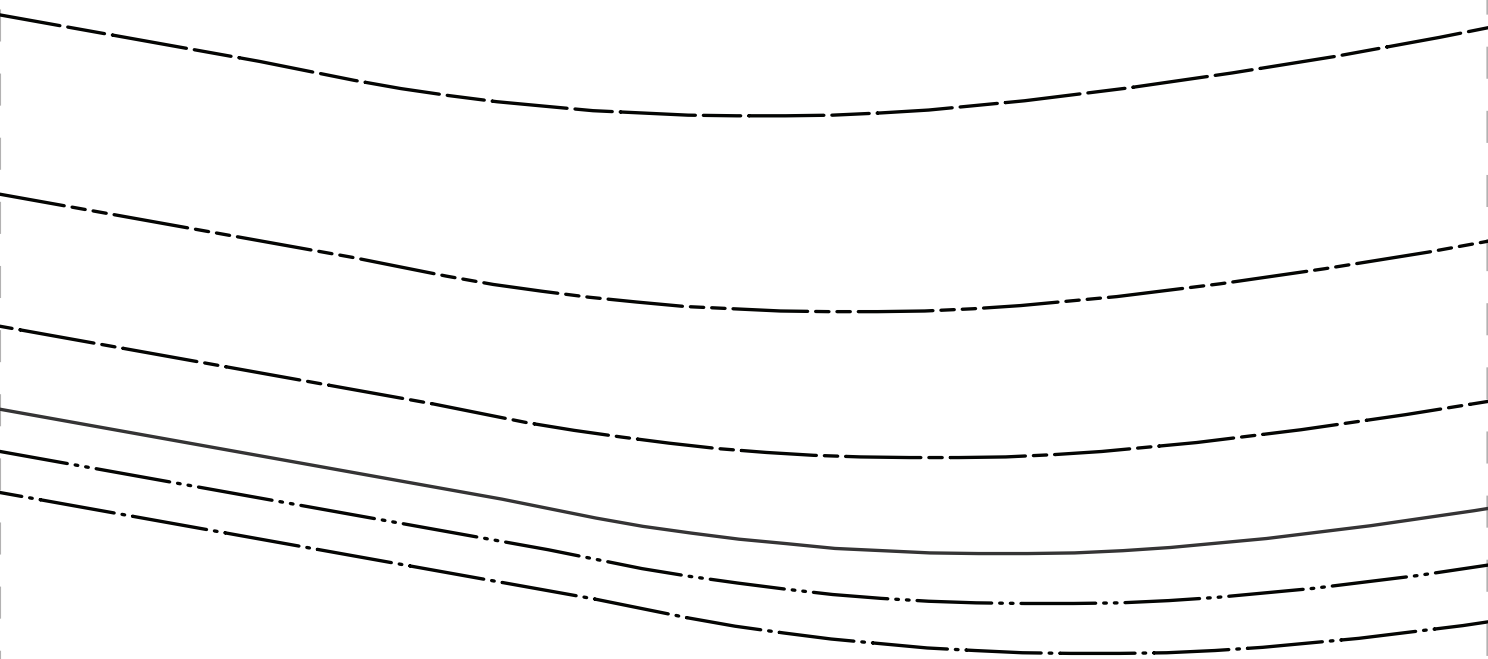

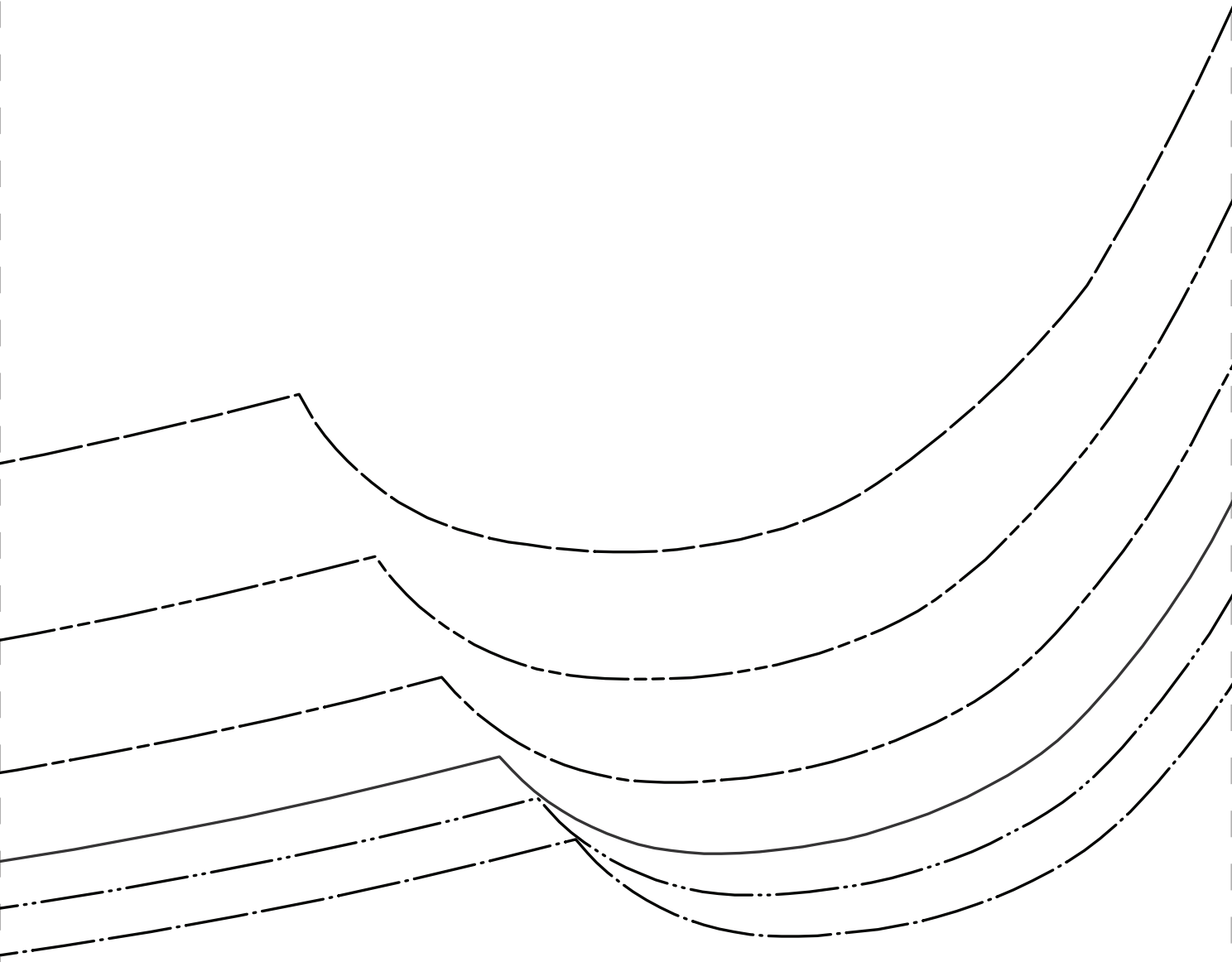

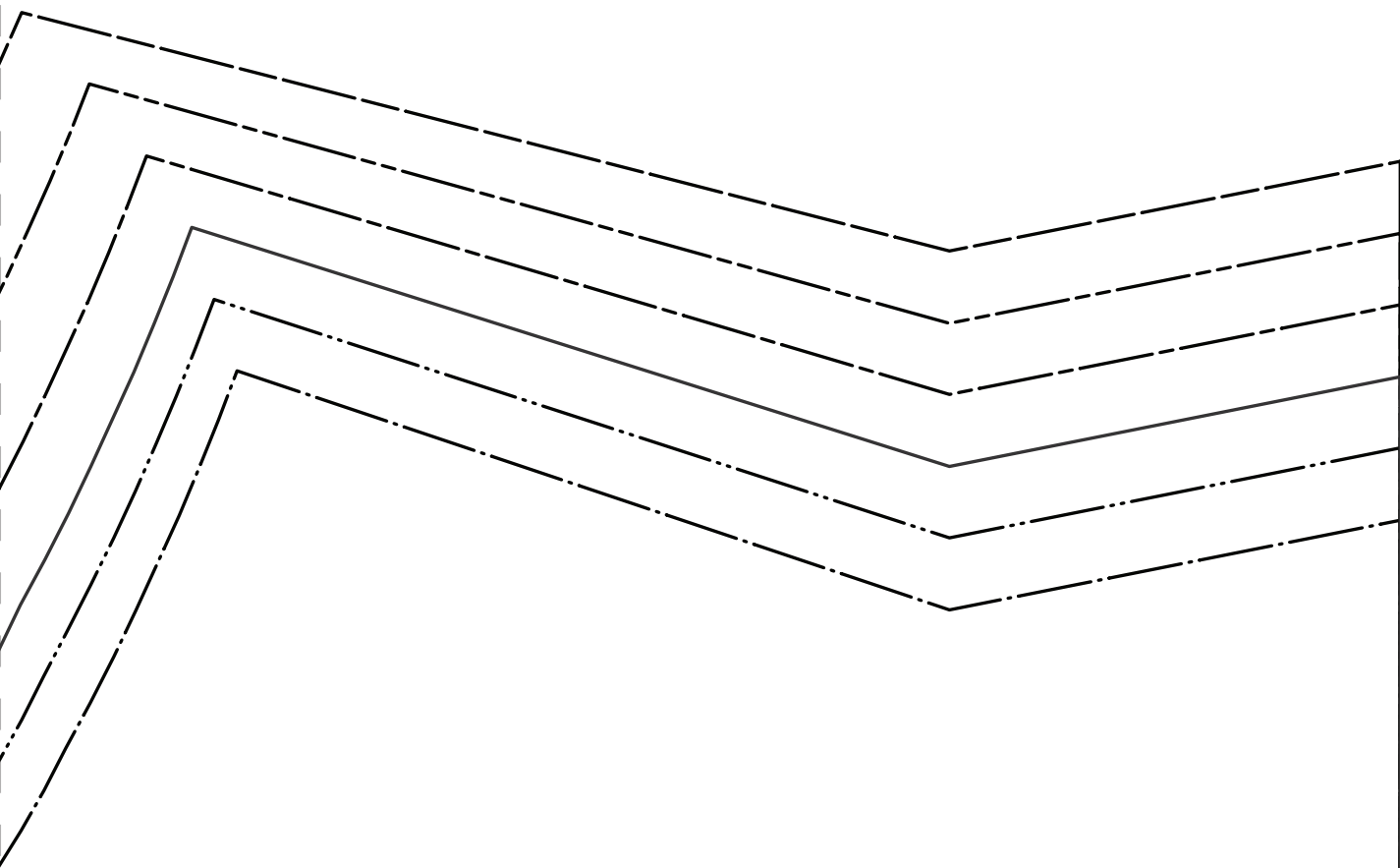

10



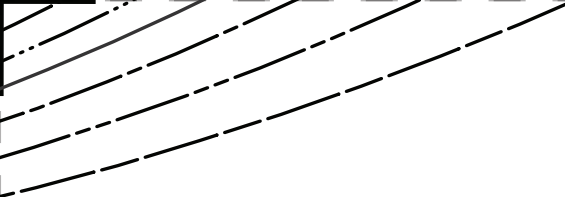

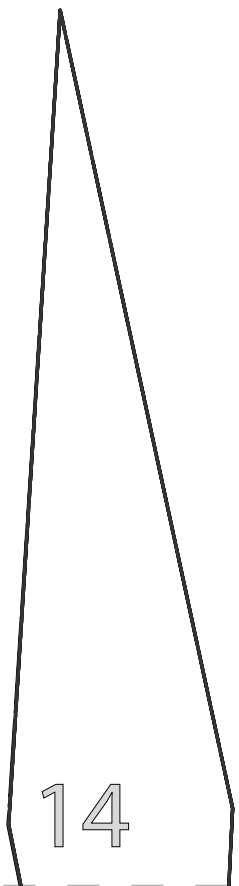
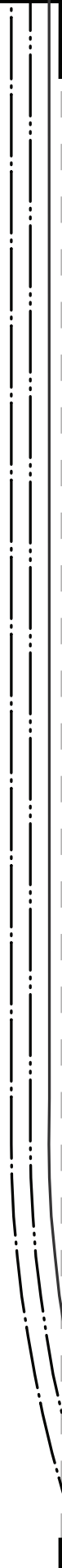

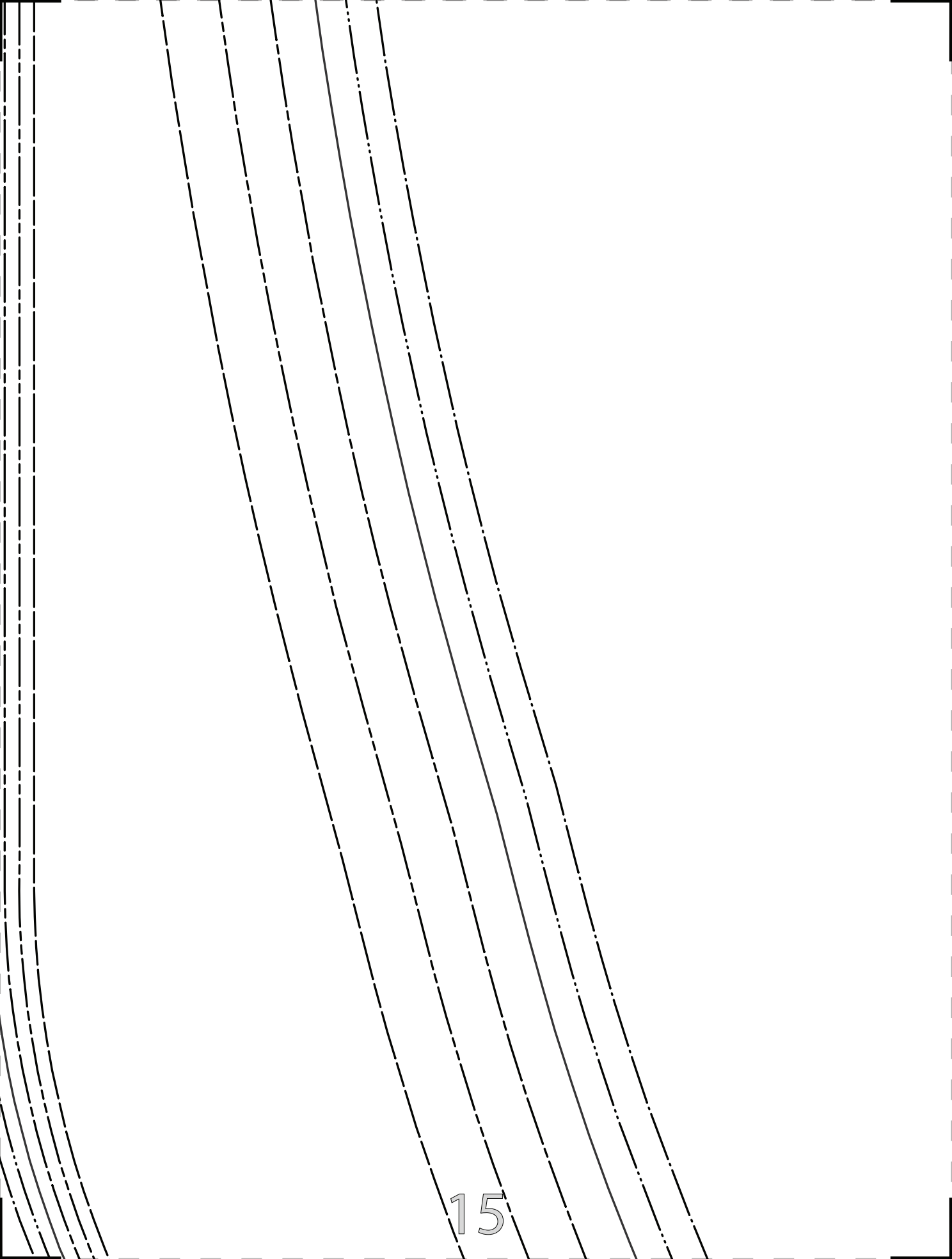



#MoodNyssaPattern

"The Nyssa Dress"
MDF044

FRONT
CUT 2 IN FABRIC

SIZE 0/2

SIZE 4/6

SIZE 8/10

SIZE 12/14

SIZE 16/18

SIZE 20/22

20t

GRAINLINE

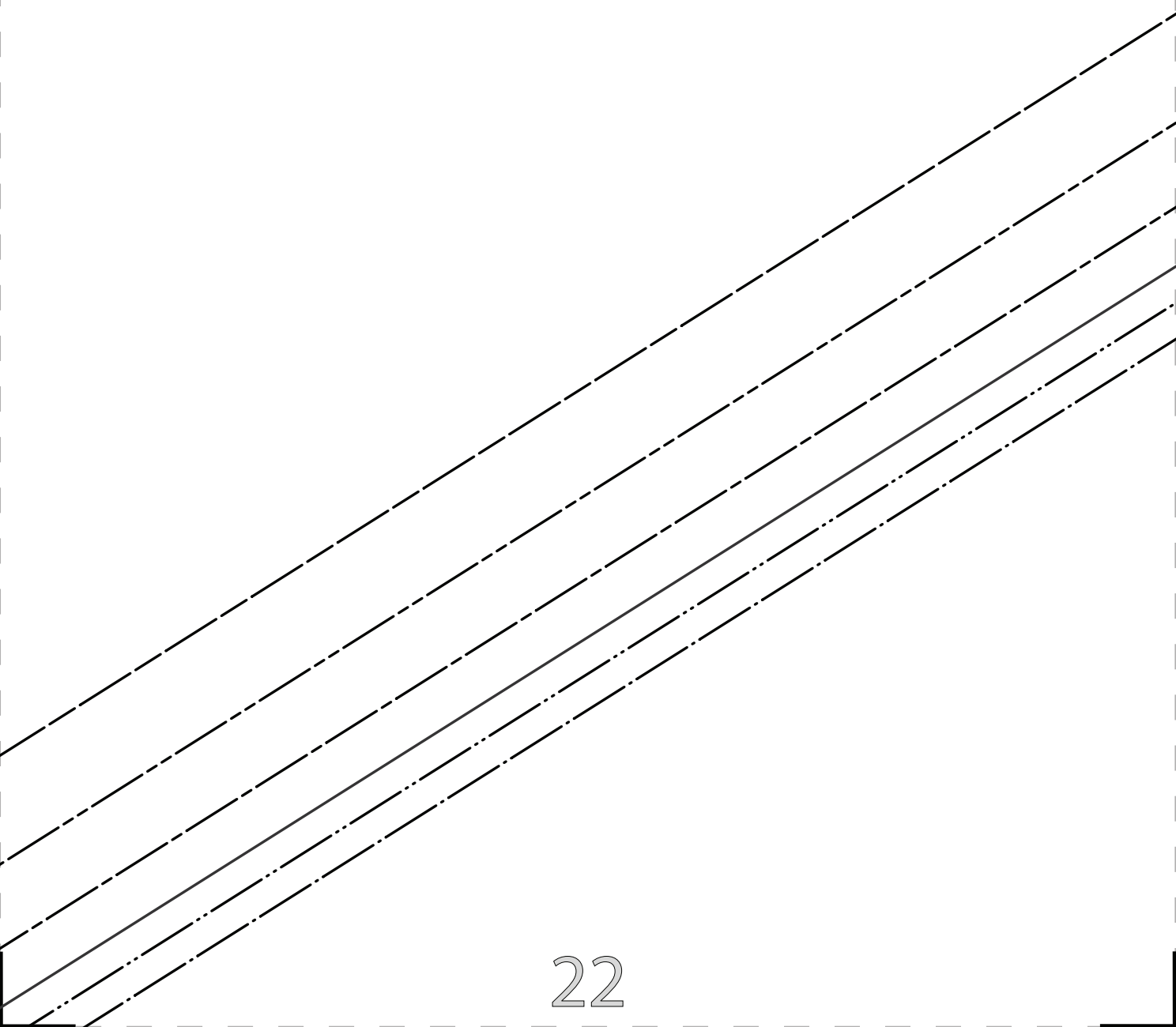

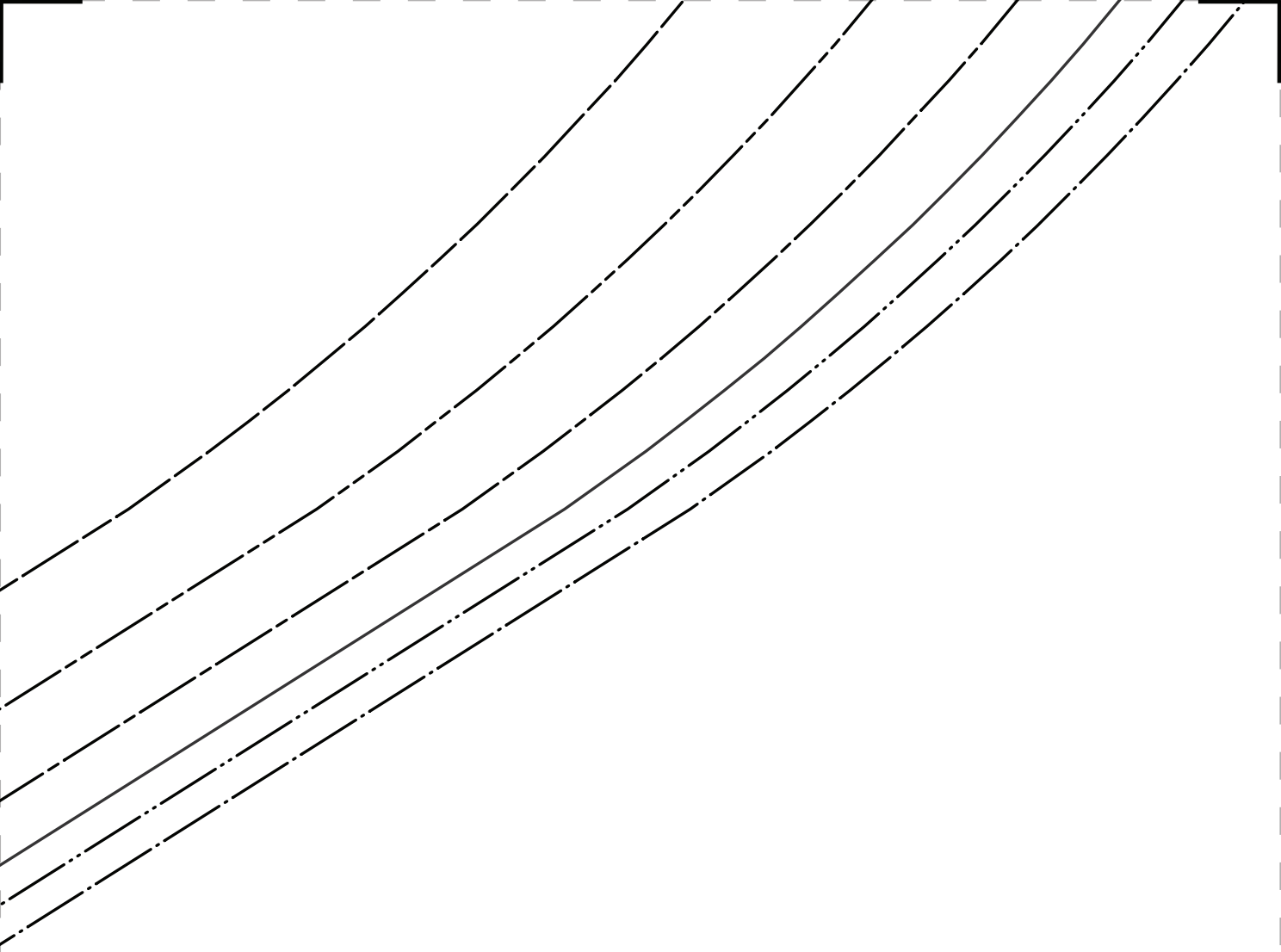

PATTERNS

BY

mod

DESIGNER FABRICS

MDF044

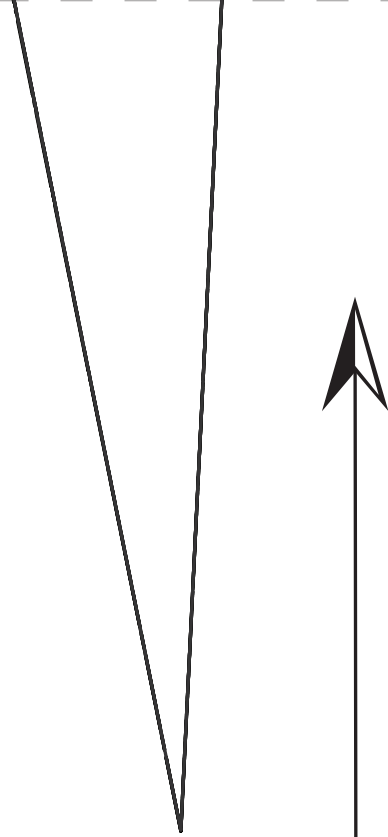

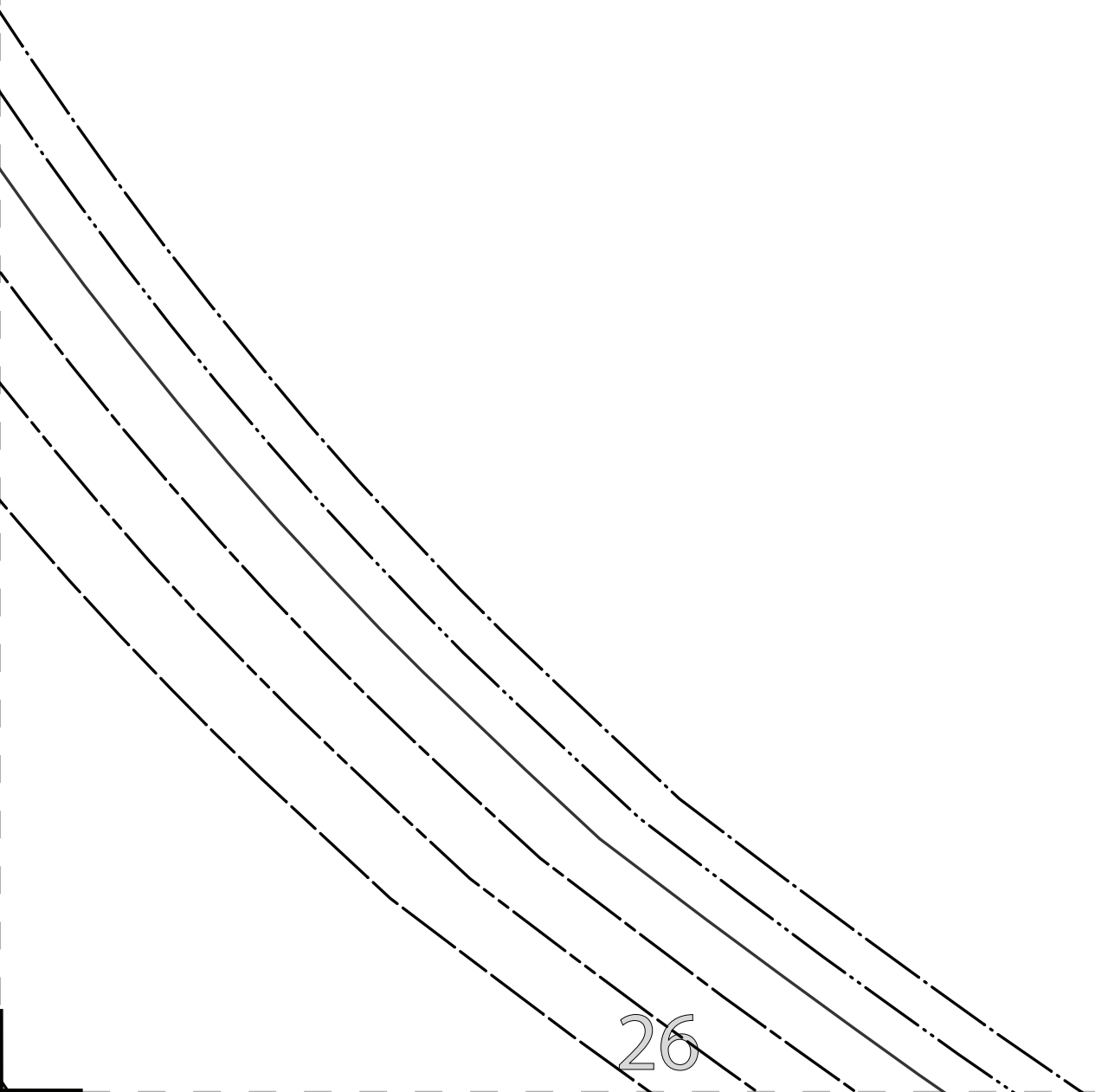



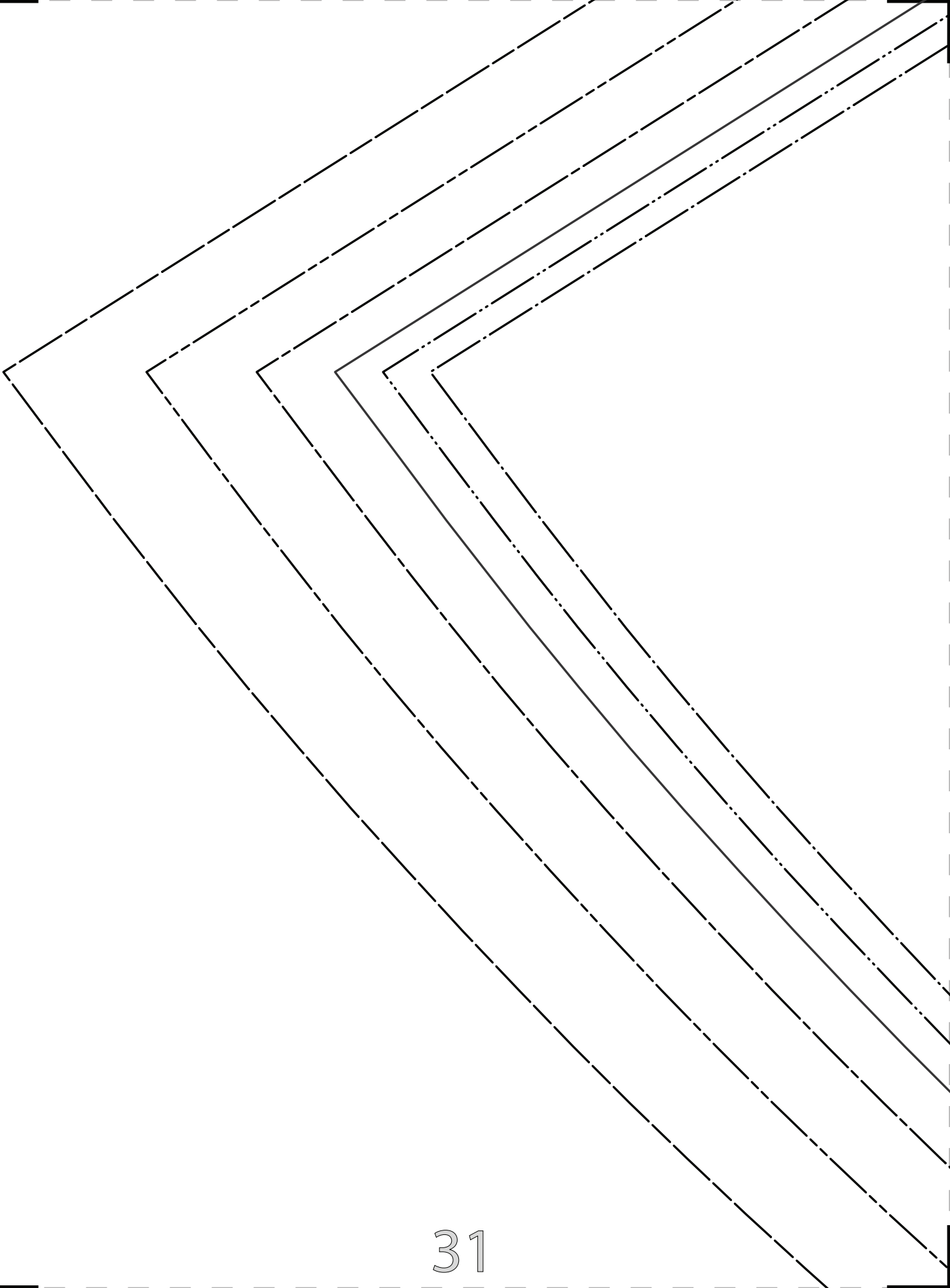

"The

CUT

SIZ
SIZ
SIZ
SIZ
SIZ
SIZ

Nyssa Dress"

MDF044

BACK
T 2 IN FABRIC

GRAINLINE

- SIZE 0/2
- SIZE 4/6
- SIZE 8/10
- SIZE 12/14
- SIZE 16/18
- SIZE 20/22

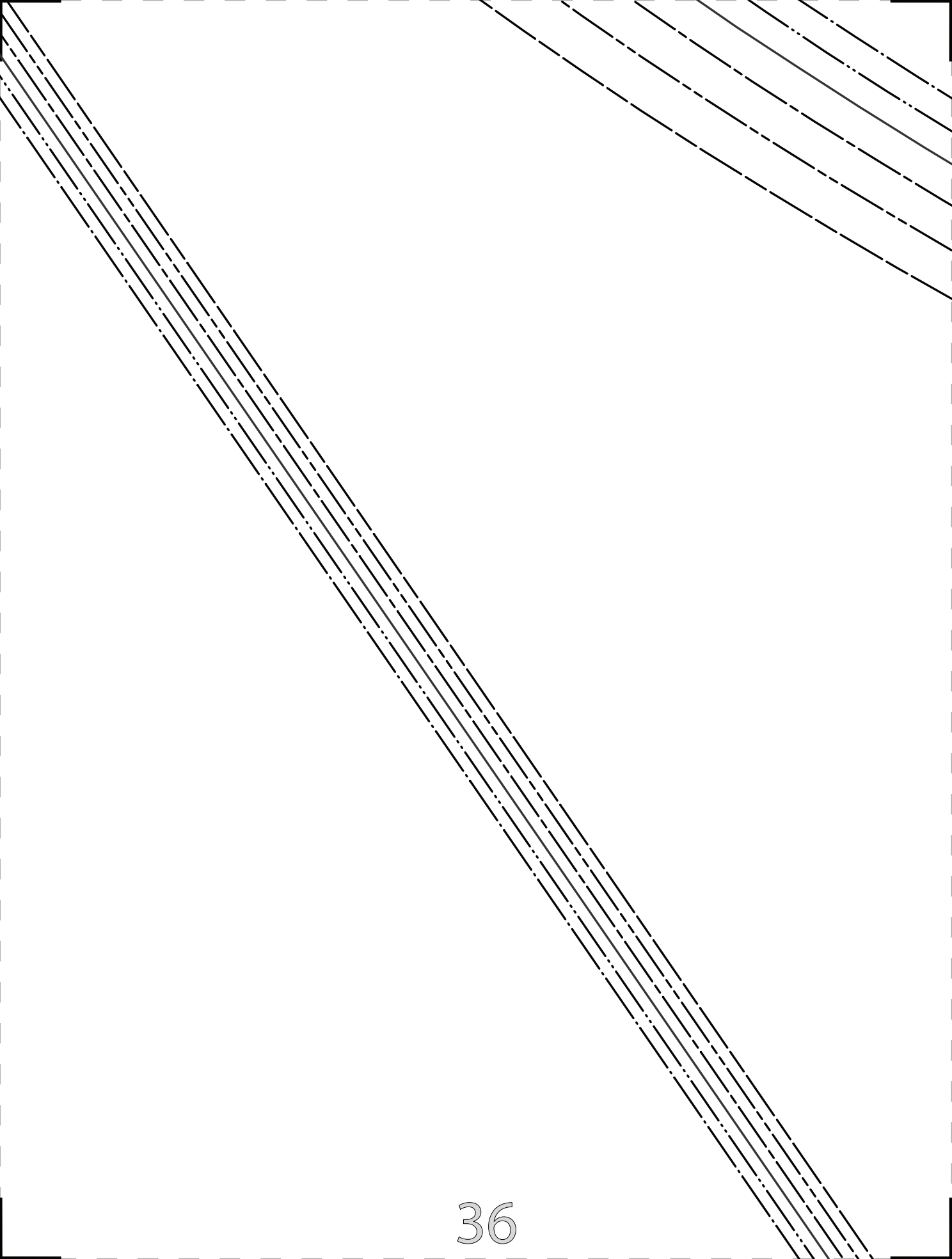

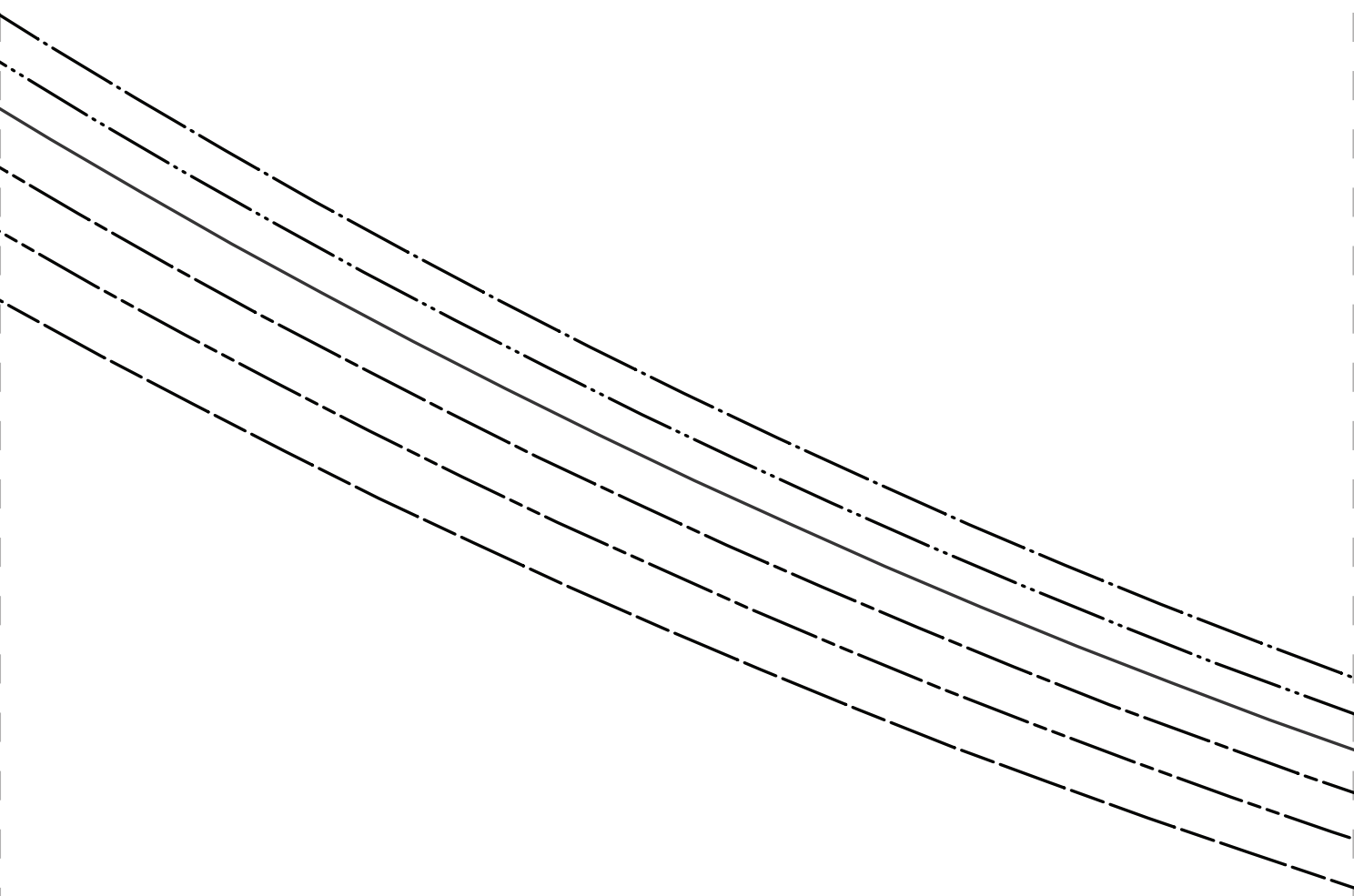

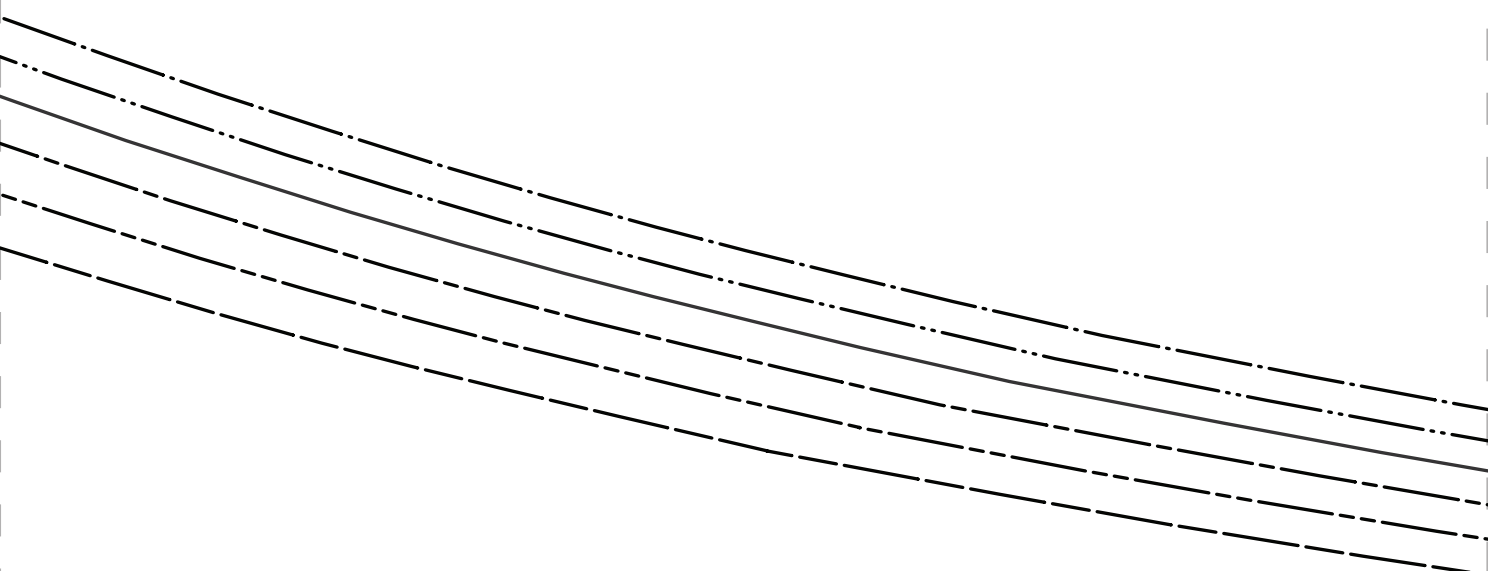

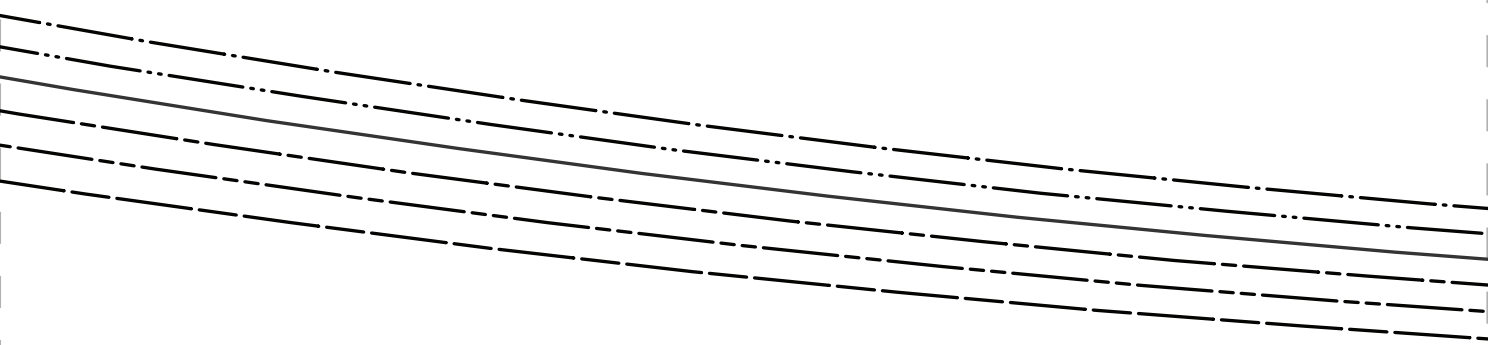

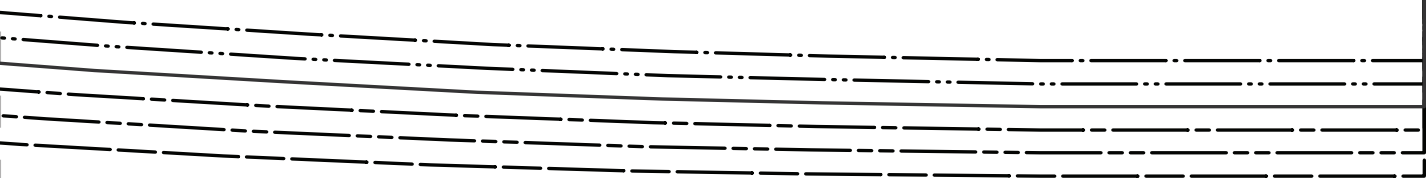

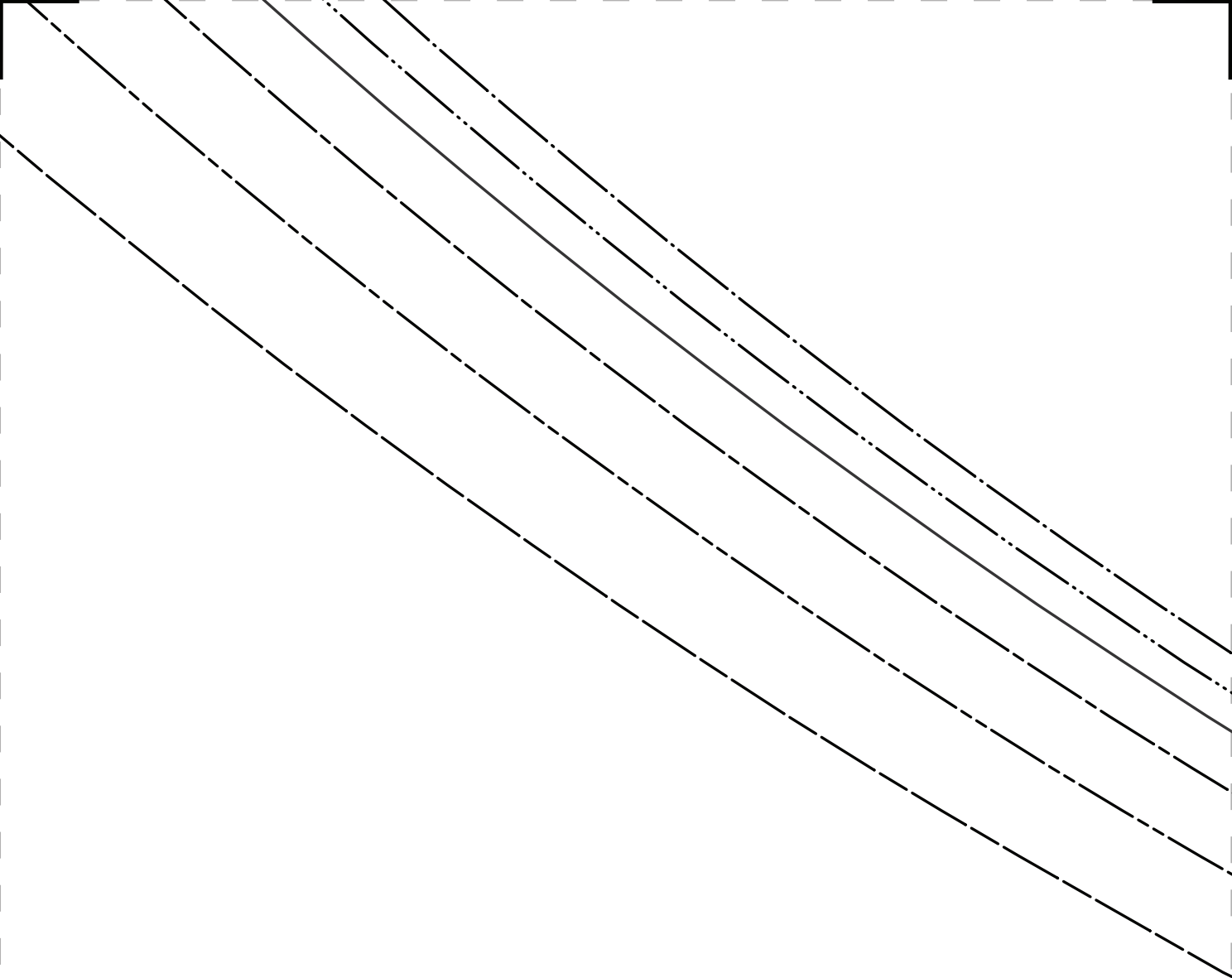

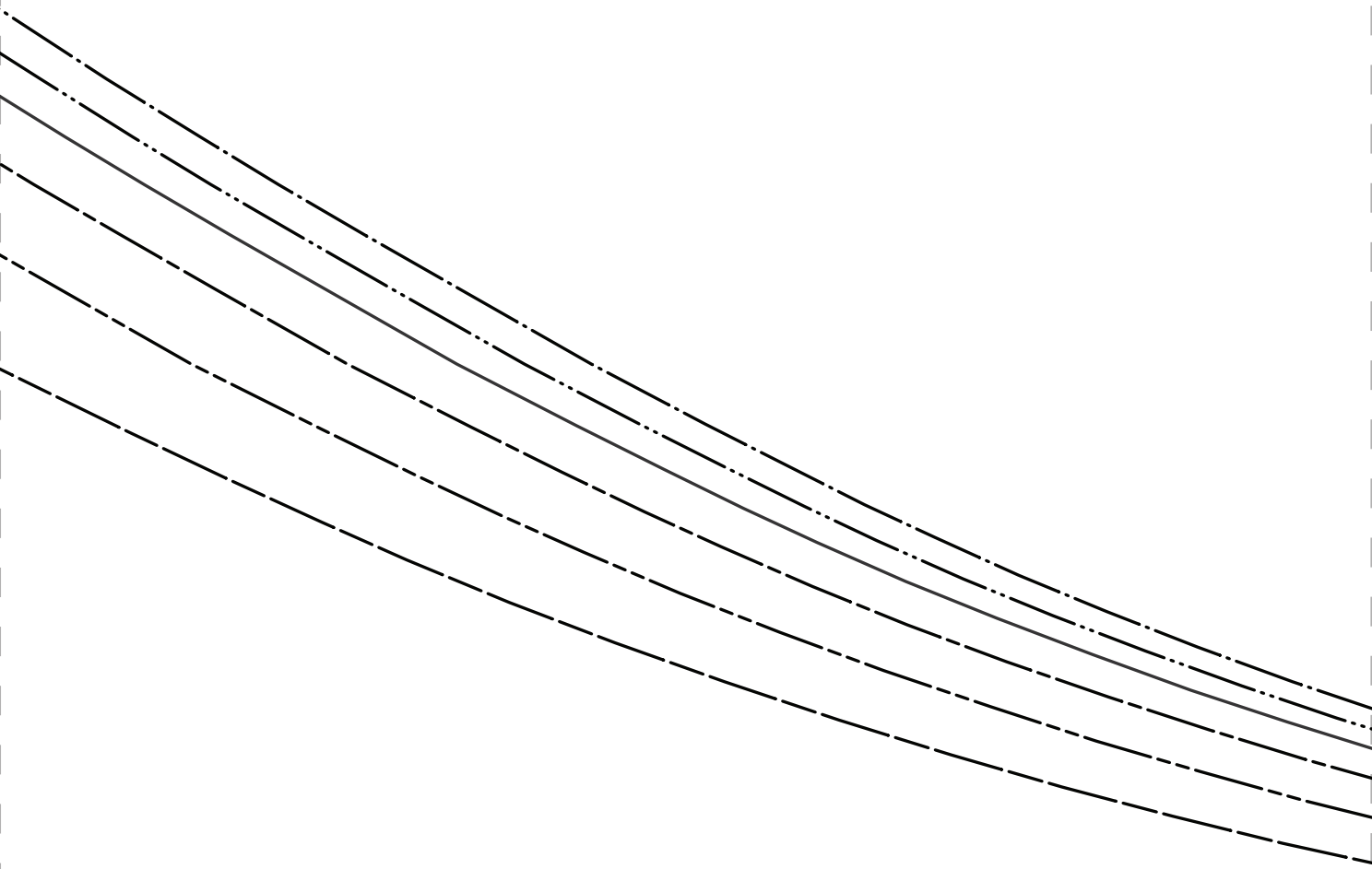

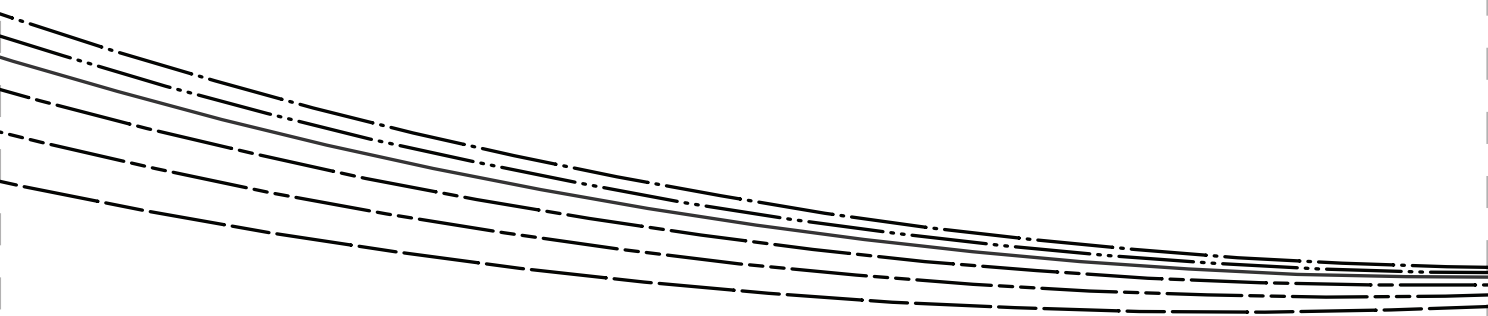

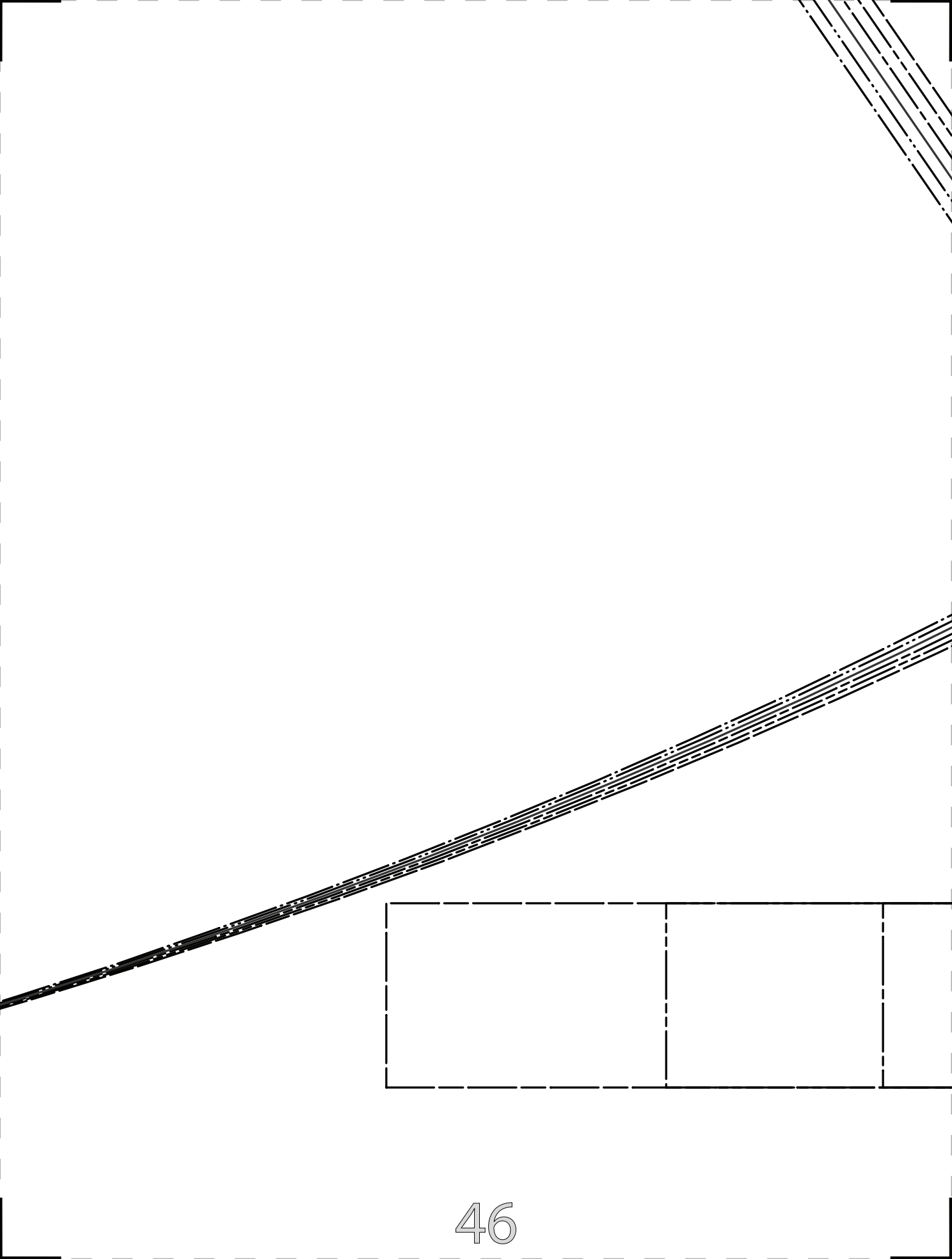

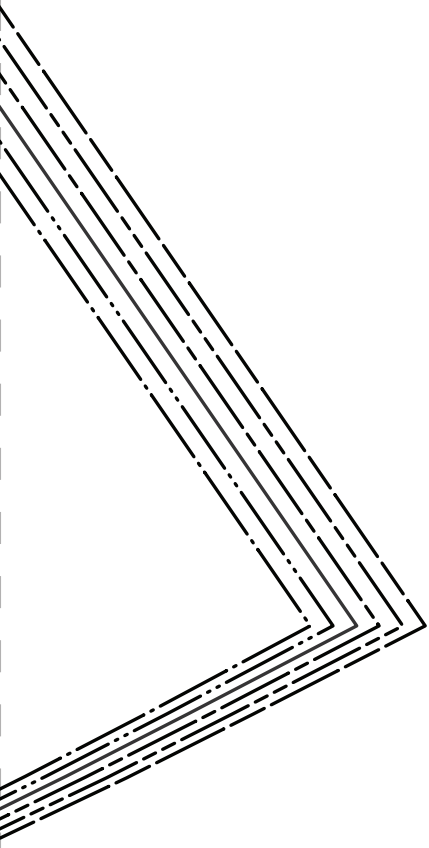

SIZE 0/2 _____
SIZE 4/6 _____
SIZE 8/10 _____
SIZE 12/14 _____
SIZE 16/18 _____
SIZE 20/22 _____



#MoodNyssaPattern

"The Nyssa Dress"
MDF044

DRAWSTRING
CUT 2 IN FABRIC
